

Example - Simple Traffic Prioritization

<https://campus.barracuda.com/doc/48203232/>

For this example, traffic must be classified into three types, according to source IP address and network service. The types should be prioritized with a ratio of 5:2:1 (**C1** : **C2** : **C3**).

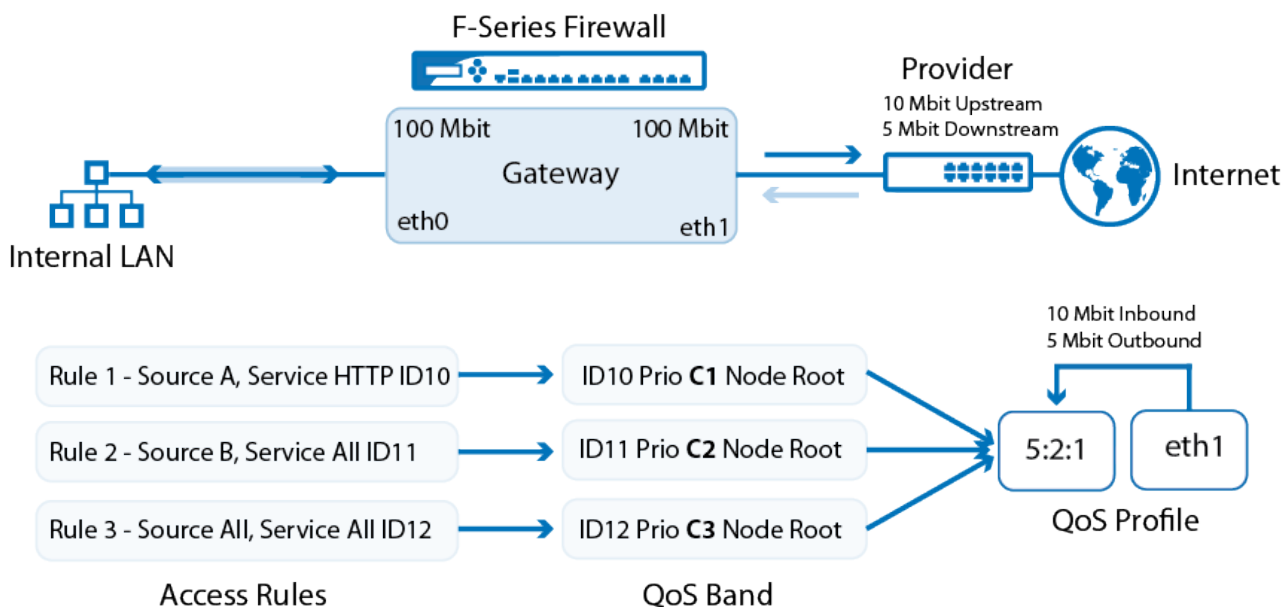

For this example, you must configure the following:

1. A [virtual tree](#) consisting of a single virtual interface with a partition priority of 5:2:1.
2. Three [QoS bands](#) that point to the **root** node. One QoS band results in a high priority, one in a medium priority, and one in a low priority.
3. A firewall ruleset that consists of three rules, each referring to one of the three QoS Bands.
4. A physical network device to which network traffic is delivered with the virtual tree attached to it.

With this configuration:

- The configured total for inbound and outbound bandwidth is never exceeded.
- The three types of network traffic (low, medium, and high) share the bandwidth. If all three types of traffic are not in operation, the total bandwidth is divided amongst the available traffic according to the partition priority. If the preset bandwidth limit is not reached, traffic shaping does not occur and there is no prioritization.

Prioritization only occurs when the available bandwidth is insufficient.

- Because all three types of traffic operate on the same limiting unit datagram and share the same datagram queue, the delivery latency of a specific traffic type is highly dependent on the amount of traffic of the other types.

- The configured priority partition is an estimated ratio. As more network traffic is sent, the closely the actual ratio matches this estimate.

Figures

1. ti_simple_traffic_prio.png

© Barracuda Networks Inc., 2019 The information contained within this document is confidential and proprietary to Barracuda Networks Inc. No portion of this document may be copied, distributed, publicized or used for other than internal documentary purposes without the written consent of an official representative of Barracuda Networks Inc. All specifications are subject to change without notice. Barracuda Networks Inc. assumes no responsibility for any inaccuracies in this document. Barracuda Networks Inc. reserves the right to change, modify, transfer, or otherwise revise this publication without notice.